

carros herramientas

Carro de Herramientas Serie ECO

Carro de herramientas de 7 cajones

Cajones sobre guías telescópicas. Protector de goma en la parte superior. Sistema de cierre centralizado con llave. Ruedas de 125mm de diámetro, muy resistentes y anchas (45mm), dos fijas y 2 móviles con freno. Disponible vacío y con equipación. Herramienta profesional (Cr-V). Peso máximo por cajón 15Kg para el primer cajón, 20Kg del segundo al quinto cajón y 25Kg para el séptimo cajón.

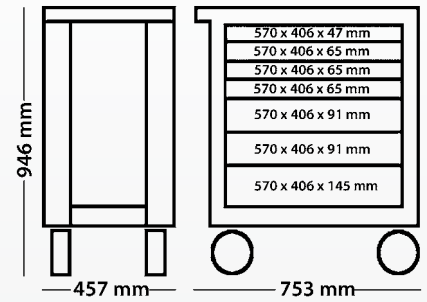

CHECO7

+	946x753x457mm
⚖	50 Kg / 90 Kg
📄	8428814930696
€	400,00 €

Encimera Serie ECO

CHECO7A

+	465x690x30mm
⚖	500 g
📄	8428814930719
€	24,00 €



V7 ECO-A

carros herramientas

Carro Con Herramienta Serie ECO

Carro de herramientas de 7 cajones

Carro Serie ECO con equipación de 157 herramientas en 5 cajones.

Suministrado con bandejas de goma EVA para que la herramienta esté siempre ordenada. 2 cajones adicionales para almacenar maquinaria y otras herramientas.

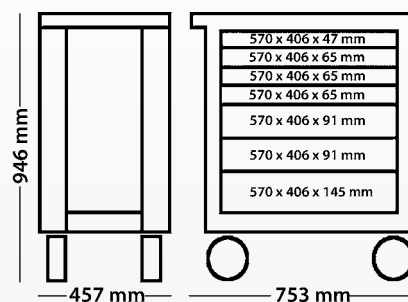

CHECO7K
+ 157 herramientas

- 946x753x457mm
- 60 Kg / 100 Kg
- 8428814930702
- 800,00 €

CHECO7K
+157



Cajón 1



Cajón 2

Dotación carro de herramientas para Serie ECO 157 pzs.

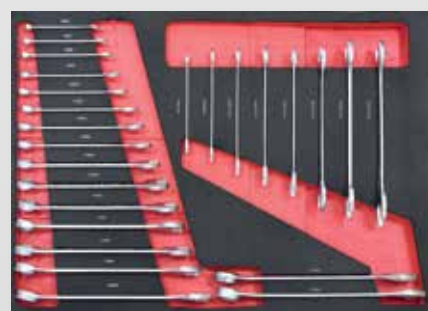

Cajón 3



Cajón 4



Cajón 5

herramienta manual

aire

maquinaria neumática

remachadoras

maquinaria eléctrica

jardín

accesorios

clavadoras grapadoras

carros herramientas

Carro de Herramientas

Carro de herramientas de 7 cajones

Cajones sobre guías telescópicas con rodamientos. Sistema anti vuelco con cierres en cada cajón, para que no se abran al estar el carro inclinado. Agarrador ergonómico integrado. Superficie superior de Polipropileno con compartimentos para piezas. Cajones compatibles con las bandejas modulares V-Tools. Sistema centralizado de cierre con llave reversible. Esquinas provistas de protección Anti-Shock contra ralladuras accidentales. Ruedas muy resistentes de 125mm, 2 fijas y dos móviles, una de ellas con freno.

CHV7

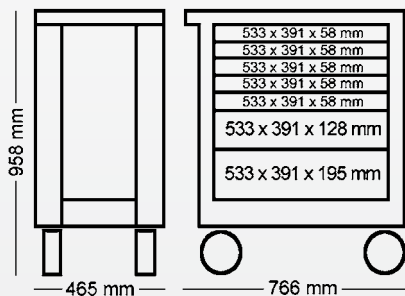

CHV7

- 958x766x465mm
- 56 Kg / 110 Kg
- 8428814930061
- 640,00 €

ACCESORIOS CARRO

Separador cajón pequeño

Separador cajón mediano

BF 1 A 6

- 392x58x2mm
- 820 g
- 8428814930597
- 3,00 €



BF 1 A 6 B

- 392x128x2mm
- 380 g
- 8428814930603
- 5,00 €



Cajón Porta Documentos

Cajón Porta Botes

BF 1 A 4

- 252x68x266mm
- 820 g
- 8428814930115
- 18,00 €



BF 1 A 5

- 252x68x109mm
- 380 g
- 8428814930146
- 15,00 €



Papelera

Bandeja + Porta Rollo Papel

BF 1 A 3 2

- 299x182x303mm
- 2.12 Kg
- 8428814930122
- 20,00 €



BF 1 A 3

- 305x310x130mm
- 1,37 Kg
- 8428814930139
- 27,00 €

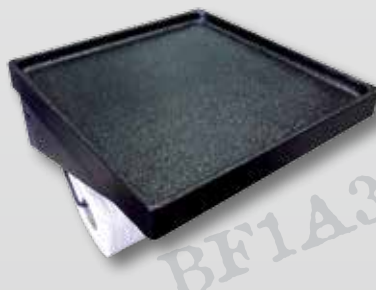

herramienta manual

aire

maquinaria neumática

remachadoras

maquinaria eléctrica

jardín

accesorios

clavadoras grapadoras

carros personalizados

Cajón 1



CHV7-35 | CHV7-48 | CHV7-49

2 Carracas de 72 dientes (1/4', 1/2')
22 Vasos 1/4' + 21 vasos 1/2'
23 Puntas 1/4'
10 Llaves hexagonales

Cajón 2



CHV7-45 | CHV7-46

22 Llaves combinadas (6 a 32mm)

Cajón 3



CHV7-05 | CHV7-44 | CHV7-72

12 Llaves acodadas (6 a 32mm)
12 Llaves combinadas con carraca (8 a 19mm)

Cajón 4



CHV7-32 | CHV7-28 | CHV7-41

10 Llaves fijas (6 a 32mm)
4 Alicates Circlip
85 Puntas, vasos y accesorios

Cajón 5



CHV7-25 | CHV7-26 | CHV7-27

7 Atornilladores planos
7 Atornilladores PH
7 Atornilladores Torx

Cajón 6



CHV7-07 | CHV7-13 | CHV7-33

2 Alicates
1 Corta-alambres
2 Martillos
1 Mordaza, 1 Pico de Loro



CHV7E
+250 herramientas

958x766x465mm

79 Kg / 100 Kg

8435572500214

1.172,00 €

PERSONALICE SU CARRO en 5 fáciles pasos!

- 1 Compre un Carro serie CHV7 vacío [Pág. 6]
- 2 Seleccione las bandejas de herramientas que necesita [Pág. 8 a 11]
- 3 Cada cajón admite 3 bandejas simples o 1 simple + 1 doble.
- 4 Complete al menos 3 cajones con herramientas.
- 5 Sume el importe y multiplique por 0.86 para obtener el precio final.

herramienta manual

aire

maquinaria neumática

remachadoras

maquinaria eléctrica

jardín

accesorios

clavadoras grapadoras

bandejas de herramientas

BANDEJAS DE HERRAMIENTAS

Herramientas de calidad profesional fabricadas en Cromo-Vanadio.

Bandejas compatibles con el carro V-7.

Presentadas en caja de cartón con ventana.

El embalaje trae 5 bandejas de cada tipo.



CHV7-05

8 llaves acodadas

8435572503611

48,00 €

1/3



CHV7-45

17 llaves combinadas

8428814930313

70,00 €

1/3



CHV7-32

10 llaves fijas

8428814930252

57,00 €

1/3

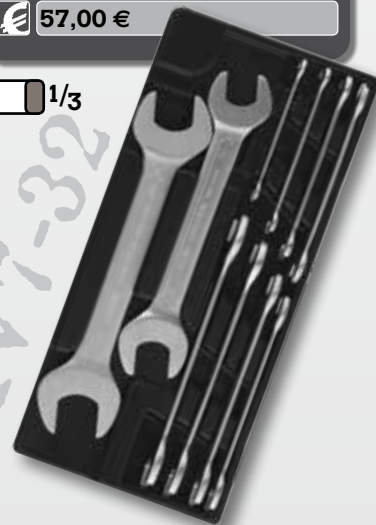

CHV7-72

12 llaves combinadas con carraca (72 dientes)

8435572500252

95,00 €

1/3



CHV7-73

12 llaves combinadas flexibles con carraca (72 dientes)

8435572504762

100,00 €

1/3



nuevo!

nuevo!

bandejas de herramientas

CHV7-30

- 6 llaves abiertas (6/24mm)
- 8428814930399
- 40,00 €

1/3



CHV7-80

- 7 llaves combinadas con carraca (72 dientes)
- 8428814970272
- 46,00 €

1/3



CHV7-90

- 7 llaves combinadas articuladas con carraca (72 dientes)
- 8428814970289
- 60,00 €

1/3



CHV7-22

- 6 atornill. eléct. + 7 atornill. precisión + 7 llaves hexag.
- 8428814930375
- 22,00 €

1/3



CHV7-17

- 4 atornill. planos + 1PH + 3TZ
- 8428814930344
- 24,00 €

1/3



CHV7-24

- 4 atornilladores planos
- 4 atornilladores PH
- 8435572503628
- 28,00 €

1/3



CHV7-25

- 7 atornilladores planos
- 8435572500221
- 32,00 €

1/3



CHV7-26

- 7 atornilladores Phillips
- 8435572500238
- 32,00 €

1/3



CHV7-27

- 7 atornilladores Torx
- 8428814930238
- 23,00 €

1/3

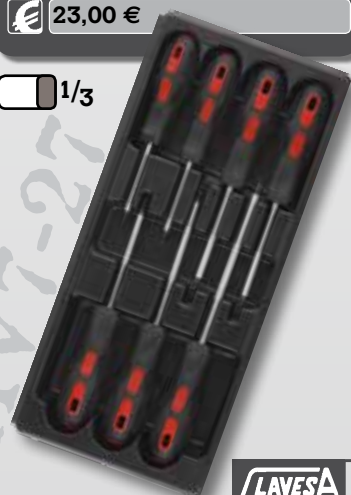

herramienta manual

aire

maquinaria neumática

remachadoras

maquinaria eléctrica

jardín

accesorios

clavadoras grapadoras

bandejas de herramientas

herramienta manual

CHV7-51

- 45 llaves combinadas
- 8428814930467
- 62,00 €

1/3



CHV7-49

- 9 vasos largos 1/4"
- 23 puntas 1/4"
- 10 llaves hexagonales
- 8428814930450
- 33,00 €

1/3



CHV7-41

- 69 puntas Hex
- 12 vasos Hex
- 2 adaptadores Hex
- 2 prolongadores
- 8428814930290
- 62,00 €

1/3



aire

maquinaria neumática

CHV7-35

- 1 carraca 1/4" (72 dientes)
- 13 vasos 1/4"
- 5 accesorios 1/4"
- 8428814930276
- 38,00 €

1/3



CHV7-36

- 1 llave carraca 3/8" (72 dientes)
- 15 vasos 3/8"
- 4 accesorios 3/8"
- 8428814930429
- 55,00 €

1/3



CHV7-37

- 1 carraca 1/2" (72 dientes)
- 17 vasos 1/2"
- 4 accesorios 1/2"
- 8428814930283
- 90,00 €

1/3

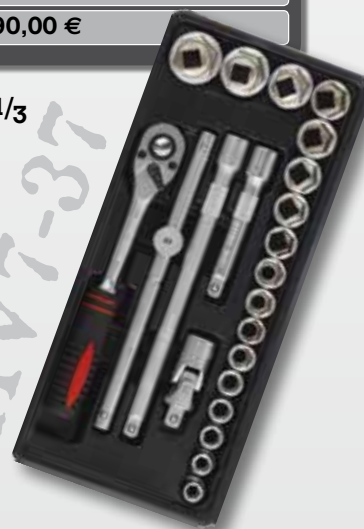

remachadoras

maquinaria eléctrica

CHV7-07

- 2 alicates
- 1 corta-alambres
- 8435572500269
- 29,00 €

1/3



CHV7-28

- 4 alicates Circlip
- 8435572500276
- 28,00 €

1/3



CHV7-33

- 1 pico de loro + 1 mordaza
- 8435572503581
- 29,00 €

1/3



jardín

accesorios

clavadoras grapadoras

bandejas de herramientas

CHV7-15

-  1 remachadora
200 remaches variados
-  8428814930337
-  18,00 €

 1/3





CHV7-19

-  1 llave Plier
200 Term. electr.
-  8428814930351
-  27,00 €

 1/3





CHV7-31

-  7 herramientas
de corte y medida
-  8428814930405
-  61,00 €

 1/3



CHV7-23

-  1 grapadora + 1 cutter
2 llaves inglesas
-  grapa 53F
-  8428814930382
-  37,00 €

 1/3



CHV7-13

-  1 martillo
1 martillo goma
-  8435572503635
-  30,00 €

 1/3





CHV7-12

-  6 llaves Allen
-  8428814930207
-  18,00 €

 1/3





CHV7-21

-  1 sierra +
herramientas de medida
-  8428814930368
-  20,00 €

 1/3



CHV7-34

-  1 bandeja vacía
para tornillería
-  8428814930412
-  8,00 €

 1/3



CHV7-34EVA

-  1 bandeja vacía
para tornillería
-  8435572503598
-  10,00 €

 1/3



nuevo!

nuevo!

herramienta
manual

aire

maquinaria
neumática

remachadoras

maquinaria
eléctrica

jardín

accesorios

clavadoras
grapadoras

juegos de llaves

herramienta manual

B2040M Juego de herramientas 40 PIEZAS 1/4'

Calidad profesional.
Fabricada en cromo-vanadio.

Incluye:

- 1 x Llave carraca 1/4' (72 dientes)
- 1 x Adaptador universal 1/4'
- 1 x Mango recto 1/4' (125 mm)
- 1 x Barra T Móvil 1/4' (65mm)
- 1 x Prolongador 1/4' (50mm)
- 13 x Vasos de 6 caras 1/4' (4, 4.5, 5, 5.5, 6, 7, 8, 9, 10, 11, 12, 13, 14mm)
- 22 x Puntas de vaso



B2040M



72 DIENTES



1,9 Kg



6940425111223



40,00 €

aire

maquinaria neumática

remachadoras

maquinaria eléctrica

jardín

accesorios

clavadoras grapadoras

B5094M / B5094MX

Juego de herramientas 94 PIEZAS 1/2'+1/4'

Calidad profesional.
Fabricada en cromo-vanadio.

Incluye:

- 2 x Llave de carraca (1/2', 1/4')
- 2 x Prolongadores 1/2' (125mm, 250mm)
- 18 x Vasos de 6 caras 1/2' (10, 11, 12, 13, 14, 15, 16, 17, 18, 19, 20, 21, 22, 23, 24, 27, 30, 32mm)
- 4 x Llaves de vaso largo 1/2' (14, 15, 17, 19mm)
- 2 x Adaptadores universales (1/4', 1/2')
- 1 x Mango recto 1/4' (150mm)
- 2 x Llaves bujías (16, 21mm)
- 2 x Prolongador 1/4' (50mm, 100mm)
- 13 x Vasos de 6 caras 1/4' (4, 4.5, 5, 5.5, 6, 7, 8, 9, 10, 11, 12, 13, 14mm)
- 3 x Llaves allen (1.5, 2, 2.5mm)
- 1 x Barra T móvil 1/2'
- 8 x Vasos largos 1/4' (6, 7, 8, 9, 10, 11, 12, 13mm)
- 1 x Barra extensible Flexible 1/4'
- 1 x Adaptador 1/2'
- 1 x Adaptador para puntas 1/4'
- 15 x Puntas 30mm (L)
- 17 x Puntas de vaso
- 1 x Barra T adaptador



B5094M



72 DIENTES



6,2 Kg



6942262900015



100,00 €

B5094MX



24 DIENTES



3 UNI. / 21 Kg



8435572502782



90,00 €

juegos de llaves

B4025M Juego de herramientas 25 PIEZAS 1/2'

Calidad profesional.
Fabricada en cromo-vanadio.

Incluye:

- 1 x Llave carraca 1/2' (72 dientes)
- 2 x Prolongadores 1/2' (125mm, 250mm)
- 1 x Barra T móvil 1/2'
- 1 x Adaptador universal 1/2'
- 2 x Llaves bujías (16, 21mm)
- 18 x Vasos de 6 caras 1/2' (10, 11, 12, 13, 14, 15, 16, 17, 18, 19, 20, 21, 22, 23, 24, 27, 30, 32mm)



B4025M



72 DIENTES



4,45 Kg



6942262900022



66,00 €

B5108MX / B5108M

Juego de herramientas 108 PIEZAS 1/2'+1/4'

Calidad profesional.
Fabricada en cromo-vanadio.

Incluye:

- 2x Llave de carraca (1/2', 1/4')
- 2x Llaves bujías 1/2' (16, 21mm)
- 17x Vasos de 6 caras 1/2' (10, 11, 12, 13, 14, 15, 16, 17, 18, 19, 20, 21, 22, 24, 27, 30, 32mm)
- 8x Vasos estrella 1/2' (E10, E11, E12, E14, E16, E18, E20, E24mm)
- 5x Llaves de vaso largo 1/2' (14, 15, 17, 19, 22mm)
- 13x Vasos de 6 caras 1/4' (4, 4.5, 5, 5.5, 6, 7, 8, 9, 10, 11, 12, 13, 14mm)
- 8x Vasos largos 1/4' (6, 7, 8, 9, 10, 11, 12, 13mm)
- 5x Vasos estrella 1/4' (E4, E5, E6, E7, E8mm)
- 17x Puntas 30mm [L]
- 18x Puntas de vaso
- 2 x Adaptadores universales (1/4', 1/2')
- 2 x Prolongadores 1/2' (125mm, 250mm)
- 1 x Barra T móvil 1/2'
- 1 x Rotula 1/2'
- 2 x Prolongador 1/4' (50mm, 100mm)
- 1 x Mango recto 1/4' (65mm)
- 1 x Barra T 1/4'
- 3 x Llaves allen (1.5, 2, 2.5mm)



B5108MX



72 DIENTES



7,21 Kg



8435572502799



110,00 €

B5108M



24 DIENTES



7,21 Kg



6940425111148



96,00 €

herramienta
manual

aire

maquinaria
neumática

remachadoras

maquinaria
eléctrica

jardín

accesorios

clavadoras
grapadoras

juegos de llaves

herramienta manual

B-0108 Juego de herramientas 108 PIEZAS 1/2' + 1/4'

Calidad semi-profesional. Fabricada en cromo-vanadio.

Incluye:

- 2 x Llave de carraca (1/2', 1/4')
- 2 x Llaves bujías 1/2' (16, 21mm)
- 17 x Vasos de 6 caras 1/2' (10, 11, 12, 13, 14, 15, 16, 17, 18, 19, 20, 21, 22, 24, 27, 30, 32mm)
- 8 x Vasos estrella 1/2' (E10, E11, E12, E14, E16, E18, E20, E24mm)
- 5 x Llaves de vaso largo 1/2' (14, 15, 17, 19, 22mm)
- 13 x Vasos de 6 caras 1/4' (4, 4.5, 5, 5.5, 6, 7, 8, 9, 10, 11, 12, 13, 14mm)
- 8 x Vasos largos 1/4' (6, 7, 8, 9, 10, 11, 12, 13mm)
- 5 x Vasos estrella 1/4' (E4, E5, E6, E7, E8mm)
- 17 x Puntas 30mm [L]
- 18 x Puntas de vaso
- 2 x Adaptadores universales (1/4', 1/2')
- 2 x Prolongadores 1/2' (125mm, 250mm)
- 1 x Barra T móvil 1/2'
- 1 x Rotula 1/2'
- 2 x Prolongador 1/4' (50mm, 100mm)
- 1 x Mango recto 1/4' (65mm)
- 1 x Barra T 1/4'
- 3 x Llaves allen (1.5, 2, 2.5mm)

B0108



24 DIENTES



7,21 Kg



8435572501983



70,00 €



B0108

aire

maquinaria neumática

remachadoras

B-0172 Juego de herramientas 172 PIEZAS

Calidad profesional. Fabricada en cromo-vanadio.

Incluye:

- 17 x Vasos 1/2" 6 Puntos (10, 11, 12, 13, 14, 15, 16, 17, 18, 19, 20, 21, 22, 24, 27, 30, 32 mm)
- 13 x Vasos 1/4" (4-4.5-5-5.5-6-7-8-9-10-11-12-13-14 mm)
- 8 x Vasos Largos 1/4" (6-7-8-9-10-11-12-13 mm)
- 5 x Vasos Largos 1/2" (14-15-17-19-22mm)
- 2 x Unión Universal (1/2", 1/4")
- 1 x Extensiones 1/2" (125 mm)
- 2 x Extensiones 1/4" (100, 50 mm)
- 2 x Vasos bujías (16, 21 mm)
- 1 x Adaptador 1/2"
- 2 x Barras correderas 1/4", 1/2"
- 1 x Mango recto 1/4"
- 18 x Puntas variadas (PH1-PH2-PZ1-PZ2-T8-T10-T15-T20-T25-T27-T30-SL4, 5.5, 6.5-HEX3, 4, 5, 6 mm)
- 1 x Acoplador 1/2", 5/16"
- 5 x Vasos E 1/4" (E4-E5-E6-E7-E8)
- 8 x Vasos E 1/2" (E10-E11-E12-E14-E16-E18-E20-E24 mm)
- 17 x Puntas L30mm (HEX: 7-8-10-12-14mm
SL: 8-10-12mm
PZ:3-4mm PH:3-4mm TX: 40-45-50-55-60mm)
- 3 x Llaves hex allen (1.5-2.5-3mm)
- 2 x Carracas 24 dientes (1/4", 1/2")
- 9 x Llaves combinadas (8-10-11-12-13-14-17-19-22 mm)
- 1 x Destornillador tester
- 1 x Llave ajustable 250mm
- 1 x Cortador
- 1 x Tijeras
- 1 x Alicata corte diagonal
- 1 x Mordaza 250mm
- 1 x Alicata punta larga
- 1 x Alicata universal
- 1 x Alicata terminales
- 2 x Destornilladores pequeños (PH1x25mm, SL5.5mmx25mm)
- 4 x Destornilladores (PH1x100mm, PH2x100mm, SL6.5mmx150mm (x2))
- 40 x Terminales

B0172



24 DIENTES



11,5 Kg



8428814930559



180,00 €



B0172

maquinaria eléctrica

jardín

accesorios

clavadoras grapadoras

llaves carraca

Llave Carraca Curva 72 dientes

Calidad profesional. Sistema de soldadura rápida.
Fabricada en Cromo-Vanadio.
Diseño de mango curvo.



B7214C
72 DIENTES
CUADRADILLO 1/4'
200 g
8428814930740
14,00 €

B7212C
72 DIENTES
CUADRADILLO 1/2'
580 g
8435572501129
22,00 €

Llave Carraca 72 dientes

Calidad profesional. Soltura rápida.
Fabricada en Cromo-Vanadio.

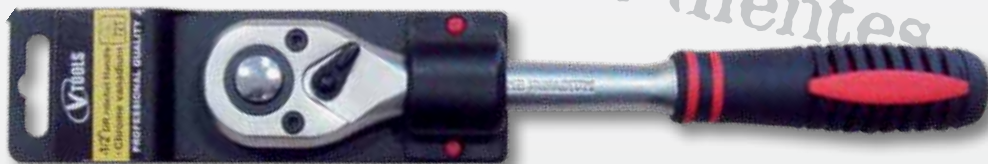

B7238M
72 DIENTES
CUADRADILLO 3/8'
420 g
8428814930573
20,00 €

Llave Carraca 24 dientes

Calidad profesional. Soltura rápida.
Fabricada en cromo-vanadio.



B2412M
24 DIENTES
CUADRADILLO 1/2'
580 g
8428814930153
14,00 €

B2438M
24 DIENTES
CUADRADILLO 3/8'
420 g
8428814930566
12,00 €

B2414M
24 DIENTES
CUADRADILLO 1/4'
150 g
8428814930160
10,00 €

Kit Llave Carraca + vasos

Calidad profesional.
Soltura rápida.
Fabricada en cromo-vanadio.

B7212MK
72 DIENTES
CUADRADILLO 1/2'
8,9 10, 11, 12, 13, 14, 15, 16, 17, 18 mm
1,260 g
8428814930092
34,00 €

B7214MK
72 DIENTES
CUADRADILLO 1/4'
4, 4.5, 5, 5.5, 6, 7, 8, 9, 10, 11, 12, 13, 14mm
390 g
8428814930108
20,00 €



herramienta
manual

aire

maquinaria
neumática

remachadoras

maquinaria
eléctrica

jardín

accesorios

clavadoras
grapadoras

Vasos Cr-V

herramienta manual

Vasos Cortos Hexagonales 1/4" (Cr-V)

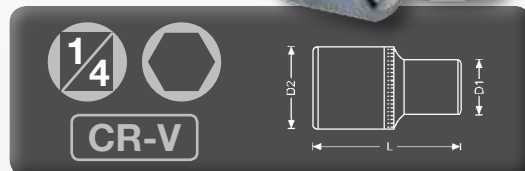
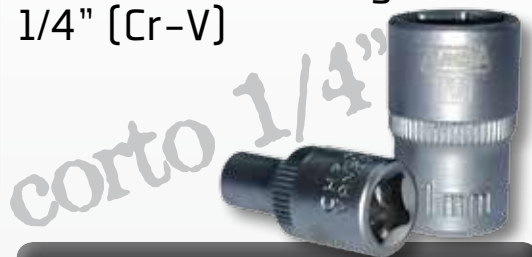

REFERENCIA	MEDIDA	L (mm)	D1 (mm)	D2 (mm)	PRECIO
BV14040	4,0 mm	25	6,9	12,5	1,40 €
BV14045	4,5 mm	25	7,9	12,5	1,40 €
BV14050	5,0 mm	25	8,2	12,5	1,40 €
BV14055	5,5 mm	25	8,8	12,5	1,40 €
BV14060	6,0 mm	25	9,4	12,5	1,40 €
BV14070	7,0 mm	25	11,0	12,5	1,40 €
BV14080	8,0 mm	25	12,2	12,5	1,40 €
BV14090	9,0 mm	25	13,5	13,5	1,60 €
BV14100	10 mm	25	14,7	14,7	1,60 €
BV14110	11 mm	25	16,0	16,0	1,80 €
BV14120	12 mm	25	17,2	17,2	2,00 €
BV14130	13 mm	25	18,5	18,5	2,00 €
BV14140	14 mm	25	19,7	19,7	2,00 €

aire

maquinaria neumática

Vasos Largos Hexagonales 1/4" (Cr-V)

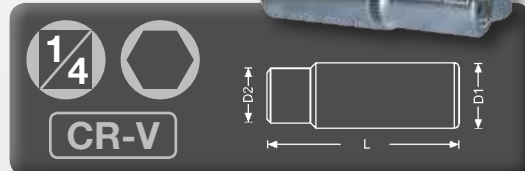
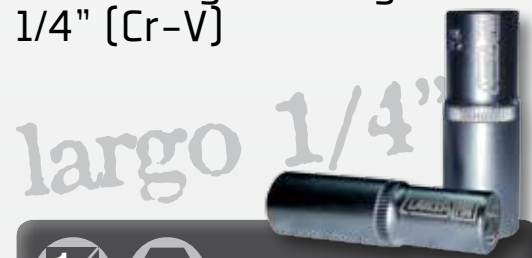

REFERENCIA	MEDIDA	L (mm)	D1 (mm)	D2 (mm)	PRECIO
BVL14060	6 mm	48,0	9,4	12,5	2,90 €
BVL14070	7 mm	48,0	11,0	12,5	2,90 €
BVL14080	8 mm	48,0	12,2	12,5	2,90 €
BVL14090	9 mm	48,0	13,5	13,5	2,90 €
BVL14100	10 mm	48,0	14,7	14,7	2,90 €
BVL14110	11 mm	48,0	16,0	16,0	3,00 €
BVL14120	12 mm	48,0	17,2	17,2	3,00 €
BVL14130	13 mm	48,0	18,5	18,5	3,20 €
BVL14140	14 mm	48,0	19,7	19,7	3,80 €

remachadoras

maquinaria eléctrica

Vasos Cortos Hexagonales 1/2" (Cr-V)

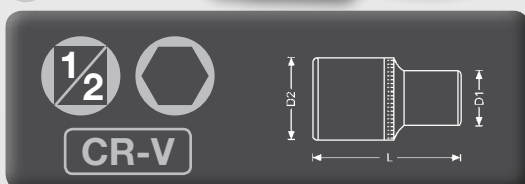

REFERENCIA	MEDIDA	L (mm)	D1 (mm)	D2 (mm)	PRECIO
BV12080	8 mm	38,0	14,0	24,0	3,00 €
BV12090	9 mm	38,0	15,0	24,0	3,00 €
BV12100	10 mm	38,0	15,5	24,0	3,00 €
BV12110	11 mm	38,0	16,7	24,0	3,00 €
BV12120	12 mm	38,0	18,0	24,0	3,00 €
BV12130	13 mm	38,0	19,2	24,0	3,00 €
BV12140	14 mm	38,0	20,5	24,0	3,00 €
BV12150	15 mm	38,0	21,7	24,0	3,00 €
BV12160	16 mm	38,0	23,0	25,5	3,00 €
BV12170	17 mm	38,0	24,2	25,5	3,20 €
BV12180	18 mm	38,0	25,5	25,5	3,40 €
BV12190	19 mm	38,0	26,7	26,7	3,40 €
BV12200	20 mm	38,0	29,2	29,2	4,00 €
BV12210	21 mm	38,0	29,2	29,2	4,00 €
BV12220	22 mm	38,0	30,5	30,5	4,40 €
BV12230	23 mm	38,0	33,0	33,0	5,00 €
BV12240	24 mm	38,0	33,0	33,0	5,20 €
BV12270	27 mm	38,0	36,7	36,7	6,40 €
BV12300	30 mm	38,0	40,5	40,5	8,80 €
BV12320	32 mm	38,0	43,0	43,0	9,40 €

jardín

accesorios

Vasos Largos Hexagonales 1/2" (Cr-V)

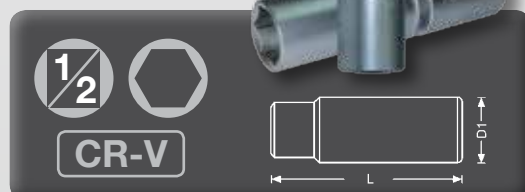

REFERENCIA	MEDIDA	L (mm)	D1 (mm)	D2 (mm)	PRECIO
BVL12150	15 mm	77,0	21,7	24,0	5,00 €
BVL12160	16 mm	77,0	23,0	25,5	5,00 €
BVL12170	17 mm	77,0	24,2	25,5	5,40 €
BVL12180	18 mm	77,0	25,5	25,5	6,20 €
BVL12190	19 mm	77,0	26,7	26,7	6,20 €
BVL12200	20 mm	77,0	29,2	26,7	6,80 €
BVL12210	21 mm	77,0	29,2	29,2	6,80 €
BVL12220	22 mm	77,0	30,5	29,2	7,20 €

clavadoras grapadoras

vasos Cr-V



Vasos Llave Impacto Largos 1/2" (Cr-V)

REFERENCIA	MEDIDA	L (mm)	D1 (mm)	D2 (mm)	PRECIO
BVI12170	17 mm	38,5	26	26	7,20 €
BVI12190	19 mm	38,5	28	28	7,50 €
BVI12210	21 mm	38,5	30	30	8,00 €

Vasos Llave Impacto Largos 3/4" (Cr-Mo)

REFERENCIA	MEDIDA	L (mm)	D1 (mm)	D2 (mm)	PRECIO
BVI34270	27 mm	90,0	44,0	44,0	18,00 €

Vasos Llave Impacto Largos 1" (Cr-Mo)

REFERENCIA	MEDIDA	L (mm)	D1 (mm)	D2 (mm)	PRECIO
BVI10300	30 mm	90,0	54,0	54,0	30,80 €
BVI10320	32 mm	90,0	54,0	54,0	30,80 €
BVI10330	33 mm	92,0	54,0	54,0	30,80 €

Juego 3 Vasos Llave Impacto Largos 1/2" (Cr-V)

REFERENCIA	MEDIDA	L (mm)	D1 (mm)	D2 (mm)	PRECIO
BVS12000	17, 19, 21 mm	38,5	26, 28, 30	26, 28, 30	24,00 €



Puntas Torx 1/4" (Cr-V)

REFERENCIA	MEDIDA	L (mm)	D (mm)	PRECIO
BB14T08	8 mm	37,0	12,0	2,00 €
BB14T10	10 mm	37,0	12,0	2,00 €
BB14T15	15 mm	37,0	12,0	2,00 €
BB14T20	20 mm	37,0	12,0	2,00 €
BB14T25	25 mm	37,0	12,0	2,00 €
BB14T27	27 mm	37,0	12,0	2,00 €
BB14T30	30 mm	37,0	12,0	2,00 €
BB14T40	40 mm	37,0	12,0	2,00 €



Puntas Hex 1/4" (Cr-V)

REFERENCIA	MEDIDA	L (mm)	D (mm)	PRECIO
BB14H03	3 mm	37,0	12,0	2,00 €
BB14H04	4 mm	37,0	12,0	2,00 €
BB14H05	5 mm	37,0	12,0	2,00 €
BB14H06	6 mm	37,0	12,0	2,00 €
BB14H07	7 mm	37,0	12,0	2,00 €
BB14H08	8 mm	37,0	12,0	2,00 €

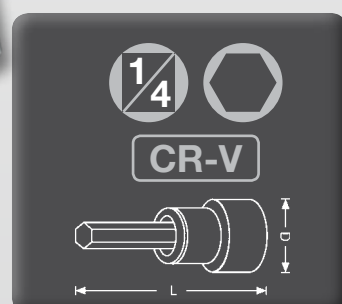
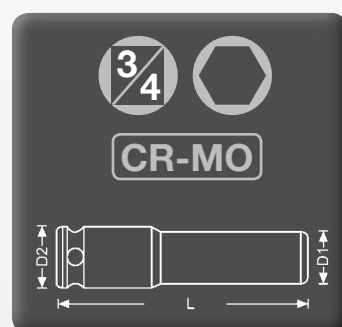
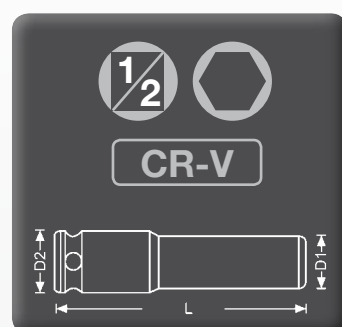

herramienta manual

aire

maquinaria neumática

remachadoras

maquinaria eléctrica

jardín

accesorios

clavadoras grapadoras

herramientas V-TOOLS

Herramientas V-TOOLS

Herramientas de calidad profesional. Mango de caucho aislante y anti-deslizante. Fabricadas en Cromo-Vanadio. Servidas con blister.

herramienta manual

aire

maquinaria neumática

remachadoras

maquinaria eléctrica

jardín

accesorios

clavadoras grapadoras

CH0060

	10" / 250 mm
	32 mm
	450 g
	8428814930542
	8,00 €



CH0060

Llave Ajustable 10"

CH0060

CH0066

	6" / 150 mm
	20 mm
	150 g
	8435572501075
	6,00 €



CH0066

Llave Ajustable 6" con mango. Dispone de escala de medición

CH0066

CH0065

	8" / 200 mm
	25 mm
	400 g
	8428814930627
	10,00 €



CH0061/CH0065

Llave Ajustable 10"/8" con mango. Dispone de escala de medición

CH0065

CH0061

	10" / 250 mm
	35 mm
	500 g
	8428814930610
	12,00 €

CH0068

	12" / 300 mm
	40 mm
	700 g
	8428814930726
	14,00 €



CH0068

Llave Ajustable 12" con mango. Dispone de escala de medición

CH0068

CH0099

	28.5x19x3 cm
	48 en 1
	520 g
	8435572503697
	18,00 €



CH0099

Llave Universal multiusos giratoria 360°. 48 herramientas en una sola. Diseño ergonómico.

CH0099

herramientas V-TOOLS y tenazas

CH0030

Alicate Corte Diagonal 7"

CH0030

	7" / 175 mm
	300 g
	8428814930511
	7,50 €

CH0010

Alicate Universal 8"

CH0010

	8" / 200 mm
	400 g
	8435572503529
	8,00 €

CH0020

Alicate Punta Plana 8"

CH0020

	8" / 200 mm
	300 g
	8428814930504
	7,00 €

CH0050

Mordaza de Presión 10"

CH0050

	10" / 250 mm
	500 g
	8435572500283
	10,00 €

CH0040

Alicate de Pico de Loro 10"

CH0040

	10" / 250 mm
	450 g
	8428814930528
	9,50 €

TC0010

Alicate de Pico de Loro 10"

TC0010

	10" / 250 mm
	320 g
	8435572501396
	6,00 €

TC0859

	CROMO VANADIO
	225 mm
	350 g
	8428814964165
	6,50 €

TC0860

	CROMO VANADIO
	250 mm
	400 g
	8435572503499
	7,60 €

TC0859 / TC0860 Tenazas

Fabricadas en acero Cr-V templado y endurecido. Dureza del cuerpo HRC 40-48. Dureza del borde de corte HRC 56-62. Acabado pulido y pintado en negro.



herramienta manual

aire

maquinaria neumática

remachadoras

maquinaria eléctrica

jardín

accesorios

clavadoras grapadoras

llaves autoajustables

herramienta manual

Juego de 9 Llaves Hexagonales

Con terminación en bola.
Fabricado en Cr-V. Medidas incluidas: 1,5, 5, 2,5, 3, 4, 5, 6, 8, 10 mm. Suministrado en blíster.



LL009H

	1,5~10 mm
	350 g
	8435572501051
	10,00 €

Juego de 9 Llaves Torx

Fabricado en Cr-V. Medidas incluidas: TH10, TH15, TH20, TH25, TH27, TH30, TH40, TH45, TH50. Suministrado en blíster.



LL009T

	TH 10~50 mm
	310 g
	8435572501068
	10,00 €

aire

maquinaria neumática

LLaves Autoajustables

Permite utilizar la misma llave para 6 diferentes medidas. Universal para tornillos en milímetros y pulgadas. Función carraca para uso más cómodo. Muy resistente. Fabricado en Cromo-Vanadio. Suministrado en colgador con función pruébame.



CH0911 CH1214 CH1517 CH1820

	9~11mm	12~14mm	15~17mm	18~20mm
	CROMO-VANADIO	CROMO-VANADIO	CROMO-VANADIO	CROMO-VANADIO
	135 mm	160 mm	190 mm	190 mm
	60 g	100 g	150 g	250 g
	8428814930641	8428814930658	8428814930665	8428814930672
	12,00 €	14,00 €	16,00 €	18,00 €

remachadoras

maquinaria eléctrica

Set LLaves Autoajustables

Incluye un juego de 4 llaves autoajustables en un maletín de plástico.



CH0920

	270x190x65mm
	1 Kg
	8428814930689
	56,00 €

jardín

accesorios

clavadoras grapadoras

cizallas y llaves Stillson

CIZALLAS Cuchillas fabricadas en acero Cr-Mo (Dureza HRC 58-60).
Brazos fabricados en acero carbono (#45)(HRC 43-48).
Empuñadura de goma.



	TC0218	TC0224	TC0230	TC0236
	7 mm	10 mm	12 mm	14 mm
	450 mm (18")	600 mm (24")	750 mm (30")	900 mm (36")
	1,89 Kg	2,89 Kg	4,05 Kg	6,35 Kg
	8435572503826	8435572501136	8428149610348	8428149610416
	28,00 €	32,00 €	42,00 €	64,00 €

LLAVES STILLSON Mordazas de acero carbono endurecido (HRC 45).
Mango de acero fundido, pintado en rojo.



	TC0325	TC0335	TC0345	TC0360	TC0390
	250 mm (10")	350 mm (14")	450 mm (18")	600 mm (24")	900 mm (36")
	0,75 Kg	1,47 Kg	2,42 Kg	3,78 Kg	6,18 Kg
	8428149640116	8428149640284	8428149640352	8428149640420	8428149640598
	9,00 €	16,00 €	20,00 €	26,00 €	40,00 €

LLAVES STILLSON (ALUMINIO) Mordazas de acero carbono endurecido (HRC 45).
Mango de aluminio que aligera la herramienta haciéndola más manejable y fácil de usar.



	TC0410	TC0414	TC0418	TC0424	TC0436
	250 mm (10")	350 mm (14")	450 mm (18")	600 mm (24")	900 mm (36")
	0,47 Kg	0,96 Kg	1,58 Kg	2,37 Kg	3,60 Kg
	8428814964110	8428814964127	8435572504281	8435572502164	8435572502157
	14,00 €	21,00 €	32,00 €	39,00 €	68,00 €

herramienta
manual

aire

maquinaria
neumática

remachadoras

maquinaria
eléctrica

jardín

accesorios

clavadoras
grapadoras





juegos de llaves

herramienta manual

Juego de llaves abiertas





Fabricadas en cromo-vanadio.
Acabado pulido.

LL1006





	6x7 a 16x17
	460 g
	8428814100839
	12,00 €



LL1008

	6x7 a 20x22
	800 g
	8428814100846
	20,00 €

LL1012

	6x7 a 30x32
	1.600 g
	8428814100853
	42,00 €



aire

maquinaria neumática



remachadoras







Juego de llaves mixtas

Fabricadas en cromo-vanadio.
Acabado pulido.





LL2006

	6,8,10,11,13,17
	400 g
	8428814100808
	10,00 €

LL2008

	6,8,10,11,13,14,17,19
	600 g
	8428814100815
	14,00 €

LL2012

	6 a 14, 17, 19, 22
	950 g
	8428814100822
	24,00 €





maquinaria eléctrica

jardín

Juego de llaves acodadas





Fabricadas en cromo-vanadio.
Acabado pulido.

LL3006



	6x7 a 16x17
	900 g
	8428814100860
	18,00 €



LL3008

	6x7 a 20x22
	1.200 g
	8428814100877
	25,00 €

LL3012

	6x7 a 30x32
	2.980 g
	8428814100884
	50,00 €



accesorios

clavadoras grapadoras

llaves combinadas con carraca

Llaves combinadas con carraca

Llaves de calidad profesional. Cada llave incluye una llave abierta fija y una carraca de estrella con 72 dientes. Fabricadas en Cromo-Vanadio. Disponibles en fija y articulada.



	LL4008	LL4009	LL4010	LL4011	LL4012	LL4013
	8 mm	9 mm	10 mm	11 mm	12 mm	13 mm
	141 mm	151 mm	161 mm	167 mm	173 mm	180 mm
	8428814970012	8428814970029	8435572500788	8428814970043	8428814970050	8435572500795
	5,50 €	5,70 €	5,90 €	6,10 €	6,30 €	6,50 €

	LL4014	LL4015	LL4016	LL4017	LL4018	LL4019
	14 mm	15 mm	16 mm	17 mm	18 mm	19 mm
	193 mm	202 mm	211 mm	227 mm	239 mm	247 mm
	8428814970074	8428814970081	8428814970098	8435572500818	8435572500825	8435572500832
	6,70 €	6,90 €	7,30 €	7,70 €	8,10 €	8,50 €



	LL5008	LL5009	LL5010	LL5011	LL5012	LL5013
	8 mm	9 mm	10 mm	11 mm	12 mm	13 mm
	141 mm	151 mm	161 mm	167 mm	173 mm	180 mm
	8428814970135	8428814970142	8428814970159	8428814970166	8428814970173	8435572500856
	6,70 €	6,90 €	7,10 €	7,50 €	7,70 €	8,10 €

	LL5014	LL5015	LL5016	LL5017	LL5018	LL5019
	14 mm	15 mm	16 mm	17 mm	18 mm	19 mm
	193 mm	202 mm	211 mm	227 mm	239 mm	247 mm
	8428814970197	8428814970203	8428814970210	8435572500863	8428814970234	8435572500900
	8,50 €	8,90 €	9,30 €	9,70 €	10,10 €	10,50 €



Juego de 7 llaves combinadas con carraca

Calidad profesional. Fabricada en cromo-vanadio. Carraca de 72 dientes. Incluye 7 llaves. Disponible con carraca Fija o Articulada.

	LL4819
	8, 10, 12, 13, 14, 17, 19 mm
	Carraca fija
	920 g
	8435572500894
	44,00 €

	LL5819
	8, 10, 12, 13, 14, 17, 19 mm
	Carraca articulada
	920 g
	8435572500900
	56,00 €

tijeras

herramienta manual

Tijeras para corte tubería

Tijeras para corte de tubería de PP, PE, PEX, PB y PVDF.

Cuchilla de Acero Carbono y cuerpo de Aluminio.

Cortes precisos con mínimo esfuerzo.

Suministrado en Blister.

aire

maquinaria neumática

remachadoras

maquinaria eléctrica

jardín

accesorios

clavadoras grapadoras



EP8001

EP8002

EP8003

EP8001

- ☑ máx. tubo 42 mm
- ↘ largo 200 mm
- ⚙ apertura manual
- ⚖ 400 g
- 📊 8435572502256
- € 20,00 €

EP8002

- ☑ máx. tubo 45 mm
- ↘ largo 230 mm
- ⚙ apertura automát.
- ⚖ 450 g
- 📊 8428814964073
- € 28,00 €

EP8003

- ☑ máx. tubo 63 mm
- ↘ largo 300 mm
- ⚙ apertura automát.
- ⚖ 600 g
- 📊 8428814964080
- € 50,00 €

Tijera corta-chapas

Tipo Americano. Hojas de acero carbono endurecido [HRC 58-62].

Corte hasta 1,8mm. Mango de goma bicolor.



TC0801

TC0803

TC0801

- 📄 Corte izquierda
- ↘ 250 mm
- ⚖ 400 g
- 📊 8428149650184
- € 14,00 €

TC0802

- 📄 Corte recto
- ↘ 250 mm
- ⚖ 400 g
- 📊 8435572500405
- € 14,00 €

TC0803

- 📄 Corte derecha
- ↘ 250 mm
- ⚖ 400 g
- 📊 8428149650320
- € 14,00 €

martillos

MARTILLOS Maza de acero de carbono forjado endurecido (Dureza HRC 50-56). Mango de madera o de fibra.

Martillo de Mecánico
Mango de fibra.



TC0501

🔪	peso maza 200 g
⊕	255 mm
👤	320 g
📊	8435572501006
€	10,00 €

TC0502

🔪	peso maza 400 g
⊕	300 mm
👤	550 g
📊	8435572501013
€	12,00 €

TC0503

🔪	peso maza 600 g
⊕	335 mm
👤	800 g
📊	8435572501020
€	14,00 €

TC0504

🔪	peso maza 800 g
⊕	350 mm
👤	1.040 g
📊	8435572501037
€	16,00 €

Martillos de Carpintero
Mango de fibra y de madera.

TC760

🔪	peso maza 600 g
⊕	320 mm
👤	810 g
📊	8435572501044
€	14,00 €



TC0722

🔪	peso 225 g
⊕	285 mm
👤	370 g
📊	8428149630148
€	6,00 €

TC0734

🔪	peso 340 g
⊕	315 mm
👤	580 g
📊	8428149630216
€	8,00 €

TC0745

🔪	peso 450 g
⊕	330 mm
👤	650 g
📊	8428149630384
€	10,00 €

TC0756

🔪	peso 565 g
⊕	335 mm
👤	730 g
📊	8428149630452
€	12,00 €

Martillos de Bola
Mango de madera.



TC0622

🔪	peso 225 g
⊕	305 mm
👤	320 g
📊	8428149620170
€	6,00 €

TC0634

🔪	peso 340 g
⊕	305 mm
👤	460 g
📊	8428149620248
€	8,00 €

TC0645

🔪	peso 450 g
⊕	335 mm
👤	600 g
📊	8428149620316
€	10,00 €

TC0668

🔪	peso 680 g
⊕	365 mm
👤	890 g
📊	8428149620484
€	13,00 €

herramienta manual

aire

maquinaria neumática

remachadoras

maquinaria eléctrica

jardín

accesorios

clavadoras grapadoras

focos proyectores

Focos proyectores recargables y eléctricos Focos pensados para la iluminación de zonas de trabajo para todas las situaciones, a batería o para conectar a la red. Gran potencia de iluminación. Resistentes al agua y a golpes y vibraciones. Además los modelos CL-0310 y CL-0312 tienen una pantalla opcional para iluminación 360°.

herramienta manual

aire

maquinaria neumática

remachadoras

maquinaria eléctrica

jardín

accesorios

clavadoras grapadoras

CL0210

	500~1000 Lúmenes
	3.7V, 4.4 Ah Li-on
	Ratio IP: IP68/IK09
	tiempo carga 4.5 h
	uso 3:00 h @1000Lm 6:00 h @500Lm
	145 x 200 x 45 mm
	400 g
	8435572501716
	80,00 €

CL-0210

Foco proyector recargable

Foco LED COB de alta calidad. Regulación de 500 a 1000 lm. Tamaño compacto y manejable. Carcasas PU para un agarre cómodo y agradable. Indicador de estado de la batería. Dispone de potente imán para fijar a superficies metálicas.



CL0310

	400~4000 Lúmenes
	11.1V, 2.6 Ah Li-on
	Ratio IP: IP65/IK07
	tiempo carga 4.5 h
	uso 2:00 h @4000Lm 15:00 h @400Lm
	280 x 220 x 87 mm
	2.8 Kg
	8435572501723
	140,00 €

CL-0310

Foco proyector recargable

Foco LED COB con lente óptica para una iluminación uniforme. Soporte giratorio con rosca M8 para colocar en un trípode. Carcasa de foam para un agarre cómodo y seguro. Salida USB (5V-1A) para recarga de móviles. Información del estado de la batería y fácil regulación de la potencia. Sistema de encendido y apagado mediante presión prolongada.



CL0312

	400~4000 Lúmenes
	Ratio IP: IP54/IK07
	280 x 220 x 87 mm
	2.8 Kg
	8435572501730
	100,00 €

CL-0312

Foco proyector eléctrico

Foco LED COB con lente óptica para una iluminación uniforme. Soporte giratorio con rosca M8 para colocar en un trípode. Carcasa de foam para un agarre cómodo y seguro. Sistema de encendido y apagado mediante presión prolongada. Suministrado con cable de entrada de 5 metros. Dispone de una salida 230 V / 8A. Protector contra sobrecarga de 17A.



CL0301

	200 g
	8435572501747
	20,00 €

CL-0301

Pantalla difusora 360°

La pantalla difusora que ilumina 360°. Compatible con los modelos CL-0310 y CL-0312. Fácil montaje.



OFERTA

OFERTA

OFERTA

linternas led recargables

Linternas LED recargables Linternas LED con batería recargable. Linternas potentes para iluminar en zonas poco accesibles. Disponen de imán potente para colocar en las partes metálicas. Temperaturas de trabajo -20°C a 50°C. Suministradas con cable USB y transformador para recarga.

Linterna LED recargable CL-0010

Cómoda y manejable, formato bolígrafo. Dos modos de iluminación, principal y secundario. Suministrado en caja de cartón. Equipado con cable USB y transformador.



CL0010

	90/50 Lúmenes
	3.7V, 750 mAh Li-on
	Ratio IP: IP20
	tiempo carga 2:00 h
	uso 4:00 h / 6:00 h
	170 x 25 x 22 mm
	50 g
	8435572500429
	26,00 €

Linterna LED recargable CL-0020

Cómoda y manejable, formato compacto. Incluye potente imán y gancho para su colocación. Pie giratorio 320°. Suministrado en caja de cartón. Equipado con cable USB y transformador.



CL0020

	250 Lúmenes
	3.7V, 1200 mAh Li-on
	Ratio IP: IP20
	tiempo carga 3:00 h
	uso 2:30 h
	130 x 66 x 29 mm
	170 g
	8435572500436
	36,00 €

Linterna LED recargable CL-0030

Resistente a golpes, sacudidas y vibraciones. Cómoda empuñadura anti deslizante. Incluye gancho y potente imán para su colocación en todas las situaciones. Pie giratorio 120°. Dos modos de iluminación, principal y foco. Foco principal regulable. Suministrado en caja de cartón. Equipado con cable y transformador.



CL0030

	100~1.000 Lúmenes
	3.7V, 2.2 Ah Li-on
	Ratio IP: IP65
	tiempo carga 3:00 h
	uso 1:30 h / 8:00 h
	total 364 x 65 x 51 mm brazo 162 x 22 x 10 mm
	270 g
	8435572500443
	60,00 €

herramienta
manual

aire

maquinaria
neumática

remachadoras

maquinaria
eléctrica

jardín

accesorios

clavadoras
grapadoras

accesorios taller

herramienta manual

TC-0105

Gato para Foso de 0.5 Ton.



TC0105

	1.135 mm
	1.950 mm
	31 Kg / 35 Kg
	8428814966039
	260,00 €

V-03

Pareja Caballetes de Apoyo de 3 Ton.



V03

	285 mm
	425 mm
	(x1) 3,15 Kg / (x2) 6,7 Kg
	8435572500399
	46,00 €

aire

maquinaria neumática

remachadoras

maquinaria eléctrica

jardín

V-01 Camilla Mecánico

Muy resistente.
Ruedas de goma.
Soporte 136 Kg.



V01

	1.020x480x120 mm
	4.3 Kg / 15 Kg
	8435572501945
	50,00 €

accesorios

clavadoras grapadoras

TC-0101

Gato Hidráulico de carretilla 2 Ton.
[Barra 43cm].

TC0101



TC0101

	140 mm
	340 mm
	8,70 Kg / 9,50 Kg
	8435572501952
	50,00 €

TC-0130

Gato Hidráulico de carretilla 3 Ton.
[Barra 53cm].



TC0130

	135 mm
	410 mm
	16,7 Kg / 18,2 Kg
	8428814966022
	95,00 €

TC-0125

Gato Hidráulico Perfil Bajo 2.5 Ton.
[Barra 1m].



TC0125

	85 mm
	455 mm
	34 Kg / 35,8 Kg
	8435572501990
	210,00 €

B0058 Multiplicador de fuerza con alargador

Relación de fuerza 1/58.
Máximo par de torsión 5.200 Nm.
Suministrado en maletín con 2 vasos 1' (32, 33).
Material 40 CR.



B0058

	5 Kg
	8428814950014
	76,00 €

herramienta manual

aire

maquinaria neumática

remachadoras

maquinaria eléctrica

jardín

accesorios

clavadoras grapadoras

Llaves dinamométricas

Llaves dinamométricas

Especialmente diseñadas para mantenimiento de neumáticos.

Cabeza de carraca profesional.

Función bi-direccional. Mango ergonómico antideslizante.

Presentado en maleta.

Máximo error 4% a izquierdas y 6% a derechas.



DI2015C

	CABEZA 1/4'
	Certificado de calibración
	3~15 Nm
	193 mm
	210 g
	8435572500306
	104,00 €

DI2035C

	CABEZA 1/4'
	Certificado de calibración
	5~25 Nm
	280 mm
	600 g
	8435572500078
	62,00 €

DI3080C

	CABEZA 3/8'
	Certificado de calibración
	10~80 Nm
	383 mm
	740 g
	8435572500313
	78,00 €

DI3110C

	CABEZA 3/8'
	Certificado de calibración
	20~110 Nm
	383 mm
	960 g
	8428814940114
	84,00 €

DI4210C

	CABEZA 1/2'
	Certificado de calibración
	40~210 Nm
	535 mm
	1.700 g
	8435572500320
	106,00 €

DI4350C

	CABEZA 1/2'
	Certificado de calibración
	70~350 Nm
	645 mm
	2.540 g
	8435572501709
	140,00 €

DI6500C

	CABEZA 3/4'
	Certificado de calibración
	100~500 Nm
	865 mm
	3.660 g
	8428814940145
	222,00 €

DI6700C

	CABEZA 3/4'
	Certificado de calibración
	140~700 Nm
	1.088 mm
	5.940 g
	8435572500337
	620,00 €

Llave dinamométrica digital

Diseñada especialmente para la industria, el automóvil y muchas otras aplicaciones. Simple de usar mediante un LCD digital que permite trabajar en 3 unidades: Nm, Ft-lbs, In-lbs. Aviso mediante sonido. Mango ergonómico antideslizante. Presentada en maleta de plástico. Máximo error 2.5% a izquierdas y 3% a derechas.

DI3200

	CABEZA 3/8'
	20~200 Nm
	570 mm
	1.600 g
	8428814940015
	170,00 €

