

remachadoras



herramienta manual

EP-6501

Remachadora manual CLAVESA

Remacha remaches hasta 4.8.
Suministrada en blíster.

EP6501

	2.4mm~4.8mm (AC) 4.8mm (AL)
	600 g
	86x256mm/cabeza 18mm
	8428814810080
	14,00 €



EP6501

aire

maquinaria neumática

remachadoras





maquinaria eléctrica

EP-6790 Remachadora manual giratoria CLAVESA

Remachadora para remaches de 2.4 hasta 4.8 mm.
Cabezal giratorio para acceder a posiciones difíciles.
Suministrada en caja de cartón.



EP6790

	Cabezal Giratorio 2.4 ~ 4.8 mm
	730 g
	284x105x32 mm
	8428814810158
	34,00 €



EP6790

jardín

accesorios

clavadoras grapadoras

remachadoras

EP-6705 Remachadora manual CLAVESA

Remacha remaches hasta 6,4 mm. Depósito para recuperación de vástagos. Reducido tamaño, fácil de manejar en cualquier posición. Mecanismo interno eficiente, mínimo esfuerzo máxima tracción.



EP6705

	3.2 ~ 6.4 mm (AC/AL)
	1.030 g
	330x115x40 mm
	8435572503147
	36,00 €

EP6705

EP-6710 Remachadora industrial 2 manos CLAVESA

Remachadora para remaches de 2.4 a 4.8 mm. Brazos largos y resistentes para facilitar el trabajo de remachado. Suministrada en caja de cartón.

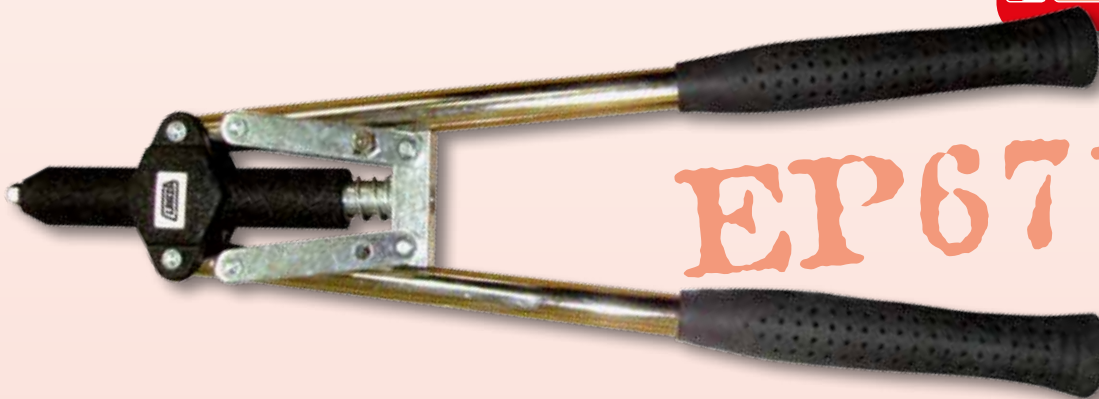

	2.4 ~ 4.8 mm (AC/AL)
	1.220 g
	489x165x40 mm
	8428814810141
	30,00 €

EP6710

EP-6700 Remachadora industrial 2 manos CLAVESA

Remachadora para remaches de 3.2 a 6.4 mm. Brazos largos y resistentes para facilitar el trabajo de remachado. Suministrada en caja de cartón.

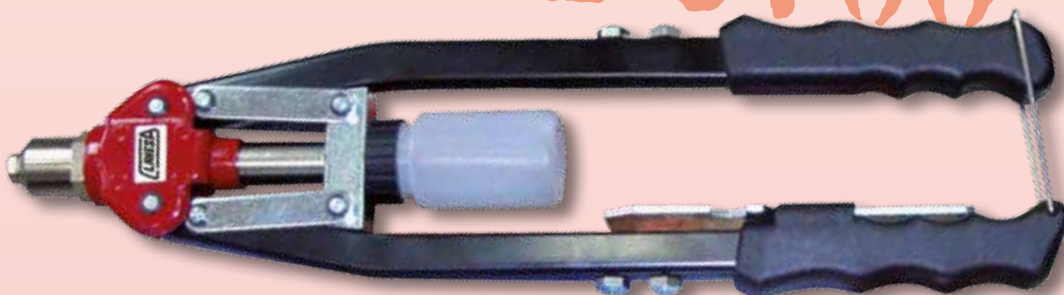

	3.2 ~ 6.4 mm (AC/AL)
	1.300 g
	410x108x38 mm
	8435572502522
	45,00 €

EP6700



herramienta manual

aire

maquinaria neumática

remachadoras

maquinaria eléctrica

jardín

accesorios

clavadoras grapadoras

remachadoras neumáticas

herramienta manual

EP-6616 Remachadora óleo-neumática CLAVESA

Remacha remaches hasta 6.4 en aluminio y en acero. Suministrada con 5 boquillas: 2.4, 3.2, 4.0, 4.8 y 6.4 mm. Sistema óleo-neumático, que permite obtener una mayor fuerza de tracción en comparación con sistemas neumáticos. Sistema de recuperación de vástagos. Suministrada en caja de cartón.

aire

maquinaria neumática

remachadoras



EP6616	
	2.4 ~ 6.4 mm (AL/AC)
	1,6 Kg
	225x275x93 mm / cabeza 24 mm
	8435572501488
	120,00 €

maquinaria eléctrica

EP-6617 Remachadora óleo-neumática CLAVESA

Remacha remaches hasta 6.4 en aluminio y en acero. Suministrada con 2 boquillas, 6'4 y 4'8 mm. Boquillas opcionales 2.4, 3.2 y 4.0 mm. Sistema óleo-neumático, que permite obtener una mayor fuerza en comparación con los sistemas neumáticos. Sistema de recuperación de vástagos. Suministrada en caja de cartón.

jardín

accesorios

clavadoras grapadoras



EP6617

EP6617	
	4.8~6.4 mm (AL/AC) 2.4~4 mm (AL/AC) opcional
	1,9 Kg
	315 x 270 mm / cabeza 23 mm
	8428814820089
	200,00 €

OFERTA

remachadoras neumáticas

REMACHADORAS SERIE PRO

Remachadoras
óleo-neumáticas CLAVESA

Calidad profesional. Sistema óleo-neumático, que permite obtener una mayor fuerza en comparación con los sistemas neumáticos. Recarga externa del depósito de aceite. Sistema de recuperación de vástagos regulable. Válvula de cierre en la toma de aire para bloquear la entrada en los tiempos sin actividad reduciendo el consumo de aire. Incluyen accesorios, llaves, boquillas, jeringuilla de recarga de aceite, botella de aceite y gancho.

EP6905



EP6905

	3.0 ~ 4 mm (AL/AC)
	19 mm / cabeza 24x700 mm
	10.300 N ~ 14.420 N
	1.42 Kg
	285x285x105 mm
	8428814820126
	320,00 €

EP6906

	4.8 ~ 6.4 mm (AL/AC)
	18 mm / cabeza 24x700 mm
	14.600 N ~ 20.440 N
	1.42 Kg
	315x290x105 mm
	8428814820133
	450,00 €



EP6908

	estándar 4.8 ~ 6.4 mm (AL/AC) monobolt 4.8 ~ 6.4 mm (AL/AC)
	26 mm / cabeza 24x660 mm
	14.225 N ~ 19.915 N
	1.80 Kg
	320x290x115 mm
	8428814820140
	672,00 €

Incluyen bote
de aceite
(100ml)
regalo!



herramienta
manual

aire

maquinaria
neumática

remachadoras

maquinaria
eléctrica

jardín

accesorios

clavadoras
grapadoras





remachadoras tuercas remachables

herramienta manual

EP-6806 PRO Remachadora manual para tuercas remachables PROFESIONAL

Remachadora de una mano.
Válida para tuercas remachables de M3 a M6.
Brazos reforzados. Suministrados los tirantes para M3, M4, M5 y M6.
Suministrada en caja de cartón.

EP6806

	M3 ~ M6
	700 g / 1.200 g
	190x120x30 mm
	8435572502829
	45,00 €







aire

maquinaria neumática

EP-6808 PRO Remachadora manual para tuercas remachables PROFESIONAL

Válida para tuercas remachables de M3 a M8. Brazos reforzados para garantizar una larga vida de la herramienta.
Suministrados todos los vástagos para las distintas medidas.
Suministrada en maleta de plástico.

EP6808

	M3 ~ M8
	650 g / 1.900 g
	300x130x40 mm
	8435572502645
	66,00 €







maquinaria eléctrica

jardín

EP-6812 PRO Remachadora manual para tuercas remachables PROFESIONAL

Válida para tuercas remachables de M3 a M12.
Brazos reforzados para garantizar una larga vida de la herramienta.
Suministrados todos los vástagos para las distintas medidas. Suministrada en maleta de plástico.

EP6812

	M3 ~ M12
	1.300 g / 3.100 g
	410x155x50 mm
	8435572502652
	80,00 €



accesorios

clavadoras grapadoras

remachadoras

EP-6991 Remachadora óleo-neumática CLAVESA para tuercas remachables

Remacha tuercas remachables de M3 a M12.
Sistema óleo-neumático, que permite obtener una mayor fuerza en comparación con los sistemas neumáticos.
Secuencia rosca-apriete-rosca que permite trabajar rápidamente con solo 1 gatillo.
Incluye boquillas y cabezales para todas las medidas.



M3
M12



incluye bote de aceite (100ml)
regalo!



EP6991

	M3 ~ M12
	21.000 N ~29.000 N
	1~8 mm/cabeza 104 x 30 mm
	280 x 290 mm x 110 mm
	1.8 Kg
	8435572503703
	1.096,00 €

EB-311 EXTRA Remachadora a batería FAR

Remachadora para remaches hasta 6 en aluminio, 5 en acero y en acero inox.
Suministrada en maleta de plástico.
Incluye 2 baterías, un cargador y una remachadora.
Batería 12v - 3Ah [Ni-Mh].



INCLUYE
2
BATERÍAS

FAEB311

	2.4 ~ 5mm (AC)/6mm (AL)
	14 mm
	15.000 Nm
	235 mm x 235 mm/cabeza 37 mm
	2,6 Kg
	8435572504120
	1.558,00 €

OFERTA

herramienta manual

aire

maquinaria neumática

remachadoras

maquinaria eléctrica

jardín

accesorios

clavadoras grapadoras

REMACHE STANDARD

Remache de aluminio con cabeza alomada. Vástago de acero con bola.

Remache estándar se utiliza para la unión de cualquier tipo de material. Mantiene una gran resistencia a la corrosión, tracción y cizallado.

d1	L	D	K	E	CAJA	PRECIO
2,4	4	4,8	0,7	0,5 - 2,0	1000	18,29 €/mil
	6	4,8	0,7	2,0 - 4,0	1000	19,42 €/mil
	8	4,8	0,7	4,0 - 6,0	1000	21,34 €/mil
	10	4,8	0,7	6,0 - 8,0	1000	23,02 €/mil
	12	4,8	0,7	8,0 - 10,0	1000	29,99 €/mil
3	6	6,0	0,9	0,5 - 3,5	1000	15,33 €/mil
	8	6,0	0,9	3,5 - 5,5	1000	16,13 €/mil
	10	6,0	0,9	5,5 - 7,0	1000	17,47 €/mil
	12	6,0	0,9	7,0 - 9,0	1000	19,70 €/mil
	14	6,0	0,9	9,0 - 11,0	500	20,86 €/mil
	16	6,0	0,9	11,0 - 13,0	500	22,66 €/mil
	18	6,0	0,9	13,0 - 15,0	500	24,64 €/mil
	20	6,0	0,9	15,0 - 17,0	500	28,39 €/mil
3,2	6	6,3	1,0	0,5 - 3,5	1000	14,39 €/mil
	8	6,3	1,0	3,5 - 5,5	1000	16,62 €/mil
	10	6,3	1,0	5,5 - 7,0	1000	18,71 €/mil
	12	6,3	1,0	7,0 - 9,0	500	20,24 €/mil
	14	6,3	1,0	9,0 - 11,0	500	21,34 €/mil
	16	6,3	1,0	11,0 - 13,0	500	23,41 €/mil
	18	6,3	1,0	13,0 - 15,0	500	25,70 €/mil
	20	6,3	1,0	15,0 - 17,0	500	28,40 €/mil
4	6	7,8	1,3	1,5 - 3,0	500	16,68 €/mil
	8	7,8	1,3	3,0 - 5,0	500	17,93 €/mil
	10	7,8	1,3	5,0 - 6,5	500	18,84 €/mil
	12	7,8	1,3	6,5 - 8,5	500	20,63 €/mil
	14	7,8	1,3	8,5 - 10,5	500	23,09 €/mil
	16	7,8	1,3	10,5 - 12,5	500	25,55 €/mil
	18	7,8	1,3	12,5 - 14,5	500	27,96 €/mil
	20	7,8	1,3	14,5 - 16,5	500	32,15 €/mil
	25	7,8	1,3	16,5 - 21,5	500	40,88 €/mil
	30	7,8	1,3	21,5 - 26,5	500	55,83 €/mil
	35	7,8	1,3	26,5 - 31,5	500	73,47 €/mil
	40	7,8	1,3	31,5 - 36,5	500	76,98 €/mil
	4,8	6	9,4	1,5	1,5 - 3,0	500
8		9,4	1,5	3,0 - 4,5	500	23,22 €/mil
10		9,4	1,5	4,5 - 6,0	500	25,09 €/mil
12		9,4	1,5	6,0 - 8,0	500	27,45 €/mil
14		9,4	1,5	8,0 - 10,0	500	30,86 €/mil
16		9,4	1,5	10,0 - 12,0	500	32,78 €/mil
18		9,4	1,5	12,0 - 14,0	500	35,83 €/mil
20		9,4	1,5	14,0 - 16,0	500	38,03 €/mil
25		9,4	1,5	16,0 - 21,0	500	41,36 €/mil
30		9,4	1,5	21,0 - 25,0	500	49,41 €/mil
35		9,4	1,5	25,0 - 30,0	500	53,42 €/mil
40		9,4	1,5	30,0 - 35,0	500	69,22 €/mil
45		9,4	1,5	35,0 - 40,0	500	76,45 €/mil
50		9,4	1,5	40,0 - 45,0	250	101,16 €/mil
55		9,4	1,5	45,0 - 50,0	250	151,39 €/mil
60	9,4	1,5	50,0 - 55,0	250	165,59 €/mil	

* medidas en milímetros.

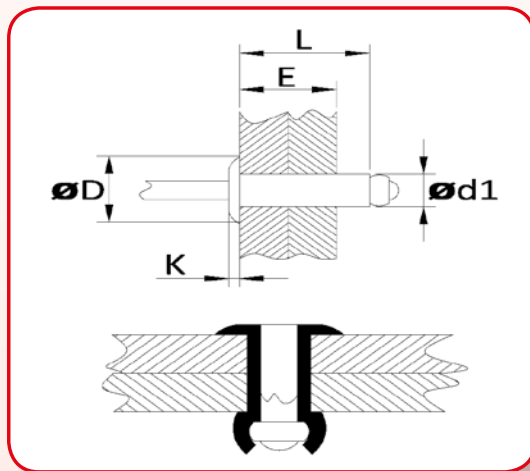

d1	L	D	K	E	CAJA	PRECIO
6	8	12	1,9	1,5 - 3,5	500	54,57 €/mil
	10	12	1,9	3,5 - 6,0	500	57,18 €/mil
	12	12	1,9	6,0 - 8,0	500	59,20 €/mil
	14	12	1,9	8,0 - 10,0	500	61,89 €/mil
	16	12	1,9	10,0 - 12,0	500	67,01 €/mil
	18	12	1,9	12,0 - 14,0	500	69,69 €/mil
	20	12	1,9	14,0 - 16,0	250	72,58 €/mil
	22	12	1,9	16,0 - 18,0	250	76,13 €/mil
	24	12	1,9	18,0 - 20,0	250	80,88 €/mil
	26	12	1,9	20,0 - 22,0	250	85,33 €/mil
	30	12	1,9	22,0 - 26,0	250	96,88 €/mil
	35	12	1,9	26,0 - 30,0	250	119,26 €/mil
	40	12	1,9	30,0 - 34,0	250	141,13 €/mil
6,4	10	13	2,0	1,5 - 4,0	500	63,00 €/mil
	12	13	2,0	4,0 - 6,0	500	67,77 €/mil
	14	13	2,0	6,0 - 8,0	500	69,66 €/mil
	16	13	2,0	8,0 - 10,0	500	75,03 €/mil
	18	13	2,0	10,0 - 12,0	250	80,80 €/mil
	22	13	2,0	12,0 - 16,0	250	90,12 €/mil
	26	13	2,0	16,0 - 20,0	250	100,65 €/mil
	30	13	2,0	20,0 - 24,0	250	109,89 €/mil
7,8	15	14,8	2,5	1,5 - 7,0	250	126,95 €/mil
	18	14,8	2,5	7,0 - 10,0	250	132,67 €/mil
	22	14,8	2,5	10,0 - 14,0	250	148,28 €/mil
	26	14,8	2,5	14,0 - 18,0	250	161,90 €/mil
	30	14,8	2,5	18,0 - 22,0	250	174,21 €/mil
	35	14,8	2,5	22,0 - 27,0	250	188,52 €/mil
	40	14,8	2,5	27,0 - 32,0	250	210,01 €/mil

* medidas en milímetros.

REMACHE STANDARD LACADO

Remache standard lacado y con cabeza alomada. Utilizado para la unión de cualquier tipo de material. Mantiene una gran resistencia a la corrosión, tracción y cizallado. Vástago de acero cincado. Se suministran en cualquier tipo de color [RAL].

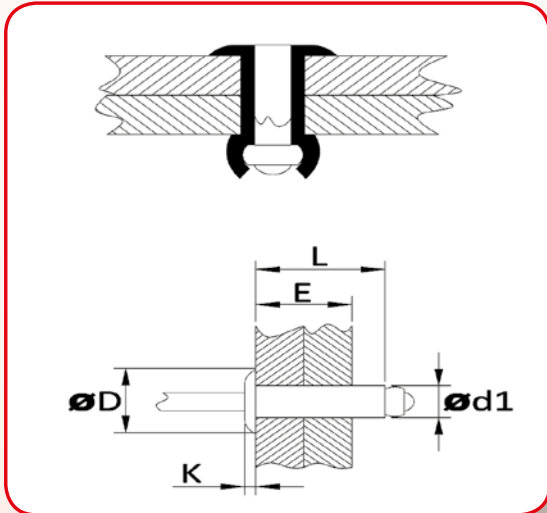

d1	L	D	K	E	CAJA	PRECIO
3	6	6,0	0,9	0,5 - 3,5	500	31,54 €/mil
	8	6,0	0,9	3,5 - 5,5	500	34,19 €/mil
	10	6,0	0,9	5,5 - 7,0	500	35,87 €/mil
	12	6,0	0,9	7,0 - 9,0	500	38,58 €/mil
	14	6,0	0,9	9,0 - 11,0	500	41,62 €/mil
	16	6,0	0,9	11,0 - 13,0	500	44,96 €/mil
	18	6,0	0,9	13,0 - 15,0	500	54,02 €/mil
3,2	6	6,3	1,0	0,5 - 3,5	500	32,21 €/mil
	8	6,3	1,0	3,5 - 5,5	500	33,34 €/mil
	10	6,3	1,0	5,5 - 7,0	500	35,44 €/mil
	12	6,3	1,0	7,0 - 9,0	500	37,84 €/mil
	14	6,3	1,0	9,0 - 11,0	500	41,64 €/mil
	16	6,3	1,0	11,0 - 13,0	500	44,33 €/mil
	18	6,3	1,0	13,0 - 15,0	500	52,99 €/mil
20	6,3	1,0	15,0 - 17,0	500	59,95 €/mil	
4	6	7,8	1,3	1,5 - 3,0	500	29,24 €/mil
	8	7,8	1,3	3,0 - 5,0	500	31,23 €/mil
	10	7,8	1,3	5,0 - 6,5	500	33,81 €/mil
	12	7,8	1,3	6,5 - 8,5	500	36,36 €/mil
	14	7,8	1,3	8,5 - 10,5	500	37,58 €/mil
	16	7,8	1,3	10,5 - 12,5	500	41,20 €/mil
	18	7,8	1,3	12,5 - 14,5	500	46,30 €/mil
	20	7,8	1,3	14,5 - 16,5	500	50,96 €/mil
	25	7,8	1,3	16,5 - 21,5	500	68,75 €/mil
30	7,8	1,3	21,5 - 26,5	500	90,83 €/mil	
4,8	6	9,4	1,5	1,5 - 3,0	500	33,35 €/mil
	8	9,4	1,5	3,0 - 4,5	500	34,83 €/mil
	10	9,4	1,5	4,5 - 6,0	500	37,47 €/mil
	12	9,4	1,5	6,0 - 8,0	500	40,90 €/mil
	14	9,4	1,5	8,0 - 10,0	500	46,71 €/mil
	16	9,4	1,5	10,0 - 12,0	500	48,59 €/mil
	18	9,4	1,5	12,0 - 14,0	500	52,65 €/mil
	20	9,4	1,5	14,0 - 16,0	500	58,59 €/mil
	25	9,4	1,5	16,0 - 21,0	500	67,20 €/mil
	30	9,4	1,5	21,0 - 25,0	500	76,56 €/mil
	35	9,4	1,5	25,0 - 30,0	500	91,45 €/mil
	40	9,4	1,5	30,0 - 35,0	500	95,91 €/mil
	45	9,4	1,5	35,0 - 40,0	500	98,89 €/mil
50	9,4	1,5	40,0 - 45,0	250	105,33 €/mil	

* medidas en milímetros.

REMACHE DE ALA ANCHA Remache de aluminio con ala ancha alomada. Vástago de acero cincado con bola. Permite distribuir mejor las cargas al tener una mayor superficie de apoyo. Recomendado para la unión de cualquier tipo de material. Mantiene una gran resistencia a la corrosión. Disponible en SUPER ALA ANCHA de diámetro 16.

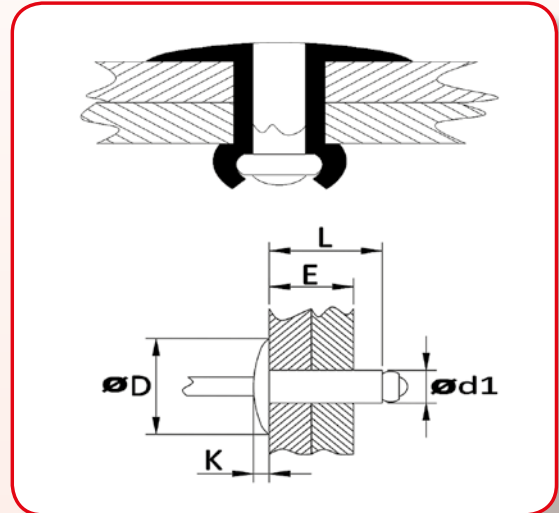

d1	L	D	K	E	CAJA	PRECIO
3,2	6	9,5	1,2	0,5 - 3,5	500	25,32 €/mil
	8	9,5	1,2	3,5 - 5,5	500	26,42 €/mil
	10	9,5	1,2	5,5 - 7,0	500	28,80 €/mil
	12	9,5	1,2	7,0 - 9,0	500	31,10 €/mil
	14	9,5	1,2	9,0 - 11,0	500	33,50 €/mil
	16	9,5	1,2	11,0 - 13,0	500	46,28 €/mil
	18	9,5	1,2	13,0 - 15,0	500	49,02 €/mil
4	6	12	1,4	1,5 - 3,0	500	31,64 €/mil
	8	12	1,4	3,0 - 5,0	500	33,66 €/mil
	10	12	1,4	5,0 - 6,5	500	36,89 €/mil
	12	12	1,4	6,5 - 8,5	500	40,25 €/mil
	14	12	1,4	8,5 - 10,5	500	43,42 €/mil
	16	12	1,4	10,5 - 12,5	500	46,30 €/mil
	18	12	1,4	12,5 - 14,5	500	49,16 €/mil
	20	12	1,4	14,5 - 16,5	500	53,42 €/mil
	25	12	1,4	16,5 - 21,5	500	92,62 €/mil
4,8	8	14	1,6	3,0 - 4,5	500	35,85 €/mil
	10	14	1,6	4,5 - 6,0	500	37,64 €/mil
	12	14	1,6	6,0 - 8,0	500	38,61 €/mil
	14	14	1,6	8,0 - 10,0	500	40,36 €/mil
	16	14	1,6	10,0 - 12,0	500	45,21 €/mil
	18	14	1,6	12,0 - 14,0	500	50,39 €/mil
	20	14	1,6	14,0 - 16,0	500	55,95 €/mil
	25	14	1,6	16,0 - 21,0	500	63,56 €/mil
	30	14	1,6	21,0 - 25,0	500	74,24 €/mil
	35	14	1,6	25,0 - 30,0	500	85,09 €/mil
	40	14	1,6	30,0 - 35,0	500	102,58 €/mil
6	8	15,1	1,9	1,5 - 3,5	500	99,25 €/mil
	10	15,1	1,9	3,5 - 6,0	500	104,30 €/mil
	12	15,1	1,9	6,0 - 8,0	500	110,46 €/mil
	15	15,1	1,9	8,0 - 12,0	500	114,72 €/mil
	18	15,1	1,9	12,0 - 14,0	500	118,58 €/mil
	20	15,1	1,9	14,0 - 16,0	250	121,35 €/mil
	24	15,1	1,9	16,0 - 20,0	250	129,75 €/mil
	26	15,1	1,9	20,0 - 22,0	250	136,33 €/mil
	30	15,1	1,9	22,0 - 26,0	250	141,33 €/mil
	35	15,1	1,9	26,0 - 30,0	250	181,61 €/mil
	40	15,1	1,9	30,0 - 34,0	250	194,23 €/mil
	45	15,1	1,9	34,0 - 38,0	250	207,75 €/mil

* medidas en milímetros.

herramienta manual

aire

maquinaria neumática

remachadoras

maquinaria eléctrica

jardín

accesorios

clavadoras grapadoras

REMACHES DE FLOR

Remache de flor con cabeza alomada. Recomendado para la unión de materiales blandos o frágiles.

Al remachar, éste se abre en cuatro pétalos produciéndose un mayor diámetro de sujeción.

Mantiene una gran resistencia a la corrosión.

Vástago de acero cincado.

También disponible en diámetro de 6 y de 6,4.

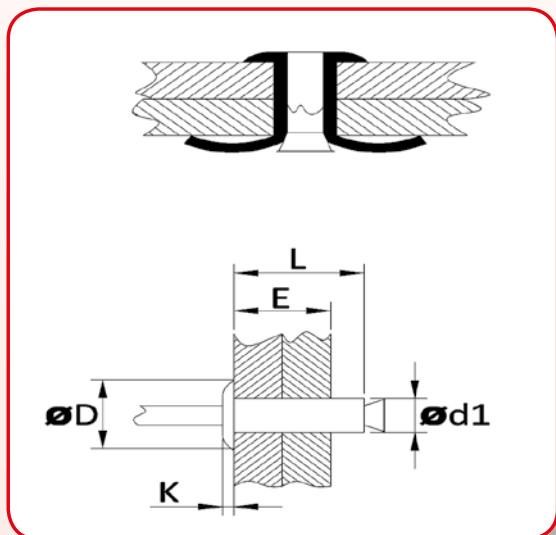

REMACHES DE FLOR Y ALA ANCHA

Remache de cabeza ancha alomada que permite distribuir mejor las cargas al tener una mayor superficie de apoyo.

El remache flor se utiliza para la unión de materiales blandos o frágiles. Al remachar, éste se abre en cuatro pétalos produciéndose un mayor diámetro de sujeción hasta en superficies desiguales. Mantiene una gran resistencia a la corrosión, al tener el vástago de acero cincado.

También disponible en ALA SUPER ANCHA de diámetro 16 mm.

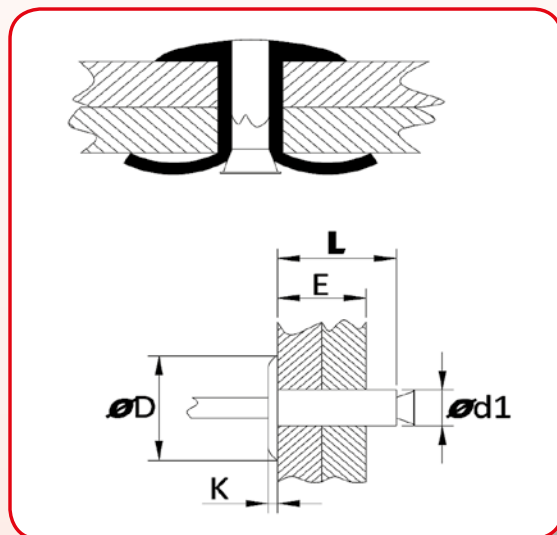

d1	L	D	K	E	CAJA	PRECIO
3,2	10	6,3	1,0	5,5 - 7,0	500	34,18 €/mil
	12	6,3	1,0	7,0 - 9,0	500	37,28 €/mil
4	8	7,8	1,3	3,0 - 5,0	500	24,87 €/mil
	10	7,8	1,3	5,0 - 6,5	500	27,82 €/mil
	12	7,8	1,3	6,5 - 8,5	500	30,01 €/mil
	14	7,8	1,3	8,5 - 10,5	500	32,08 €/mil
	16	7,8	1,3	10,5 - 12,5	500	35,31 €/mil
	18	7,8	1,3	12,5 - 14,5	500	38,03 €/mil
	20	7,8	1,3	14,5 - 16,5	500	44,81 €/mil
	25	7,8	1,3	16,5 - 21,5	500	57,08 €/mil
4,8	30	7,8	1,3	21,5 - 26,5	500	66,30 €/mil
	8	9,4	1,5	3,0 - 4,5	500	34,22 €/mil
	10	9,4	1,5	4,5 - 6,0	500	36,12 €/mil
	12	9,4	1,5	6,0 - 8,0	500	38,94 €/mil
	14	9,4	1,5	8,0 - 10,0	500	43,07 €/mil
	16	9,4	1,5	10,0 - 12,0	500	45,33 €/mil
	18	9,4	1,5	12,0 - 14,0	500	48,15 €/mil
	20	9,4	1,5	14,0 - 16,0	500	54,98 €/mil
	25	9,4	1,5	16,0 - 21,0	500	56,91 €/mil
	30	9,4	1,5	21,0 - 25,0	500	60,98 €/mil
	35	9,4	1,5	25,0 - 30,0	500	62,22 €/mil
	40	9,4	1,5	30,0 - 35,0	500	76,32 €/mil
45	9,4	1,5	35,0 - 40,0	500	87,57 €/mil	
50	9,4	1,5	40,0 - 45,0	250	118,36 €/mil	
55	9,4	1,5	45,0 - 50,0	250	228,94 €/mil	
60	9,4	1,5	50,0 - 55,0	250	262,28 €/mil	

* medidas en milímetros.

d1	L	D	K	E	CAJA	PRECIO
4	8	12,0	1,5	3,0 - 5,0	500	34,02 €/mil
	10	12,0	1,5	5,0 - 6,5	500	37,47 €/mil
	12	12,0	1,5	6,5 - 8,5	500	46,00 €/mil
	14	12,0	1,5	8,5 - 10,5	500	52,57 €/mil
	16	12,0	1,5	10,5 - 12,5	500	58,51 €/mil
	18	12,0	1,5	12,5 - 14,5	500	64,55 €/mil
4,8	20	12,0	1,5	14,5 - 16,5	500	76,46 €/mil
	25	12,0	1,5	16,5 - 21,5	500	87,81 €/mil
	10	14,0	1,8	4,5 - 6,0	500	39,74 €/mil
	12	14,0	1,8	6,0 - 8,0	500	44,85 €/mil
	14	14,0	1,8	8,0 - 10,0	500	51,92 €/mil
	16	14,0	1,8	10,0 - 12,0	500	55,72 €/mil
	18	14,0	1,8	12,0 - 14,0	500	61,31 €/mil
	20	14,0	1,8	14,0 - 16,0	500	68,39 €/mil
	25	14,0	1,8	16,0 - 21,0	500	74,48 €/mil
	30	14,0	1,8	21,0 - 25,0	500	86,54 €/mil
35	14,0	1,8	25,0 - 30,0	500	93,36 €/mil	
40	14,0	1,8	30,0 - 35,0	500	112,12 €/mil	

* medidas en milímetros.

Otros remaches disponibles

También disponemos de otros remaches
Consúltenos precios y medidas

- Flor Lacado
- Ala Ancha Lacado
- Avellanado (120°)
- Estanco
- Avellanado y Estanco
- Acanalado / Ranurado
- Multiespesor
- Multiespesor Ala Ancha
- Trébol
- Aluminio
- Acero
- Inox

remache roscado

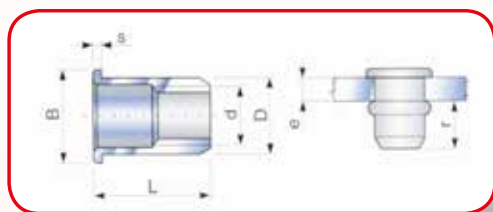

FTT

Remache Roscado Cabeza Normal



REFERENCIA	REMACHE ROSCADO FTT [CON CABEZA / BALONA]	E	D	B	S	L	CAJA	PVP
FAFTTC3	REMACHE ROSC M 3	0,3 - 1,8	4,9	7	0,8	9,0	10.000	56,00 € /mil
FAFTTC4	REMACHE ROSC M 4	0,3 - 2,5	5,9	9	1,0	11,0	10.000	60,00 € /mil
FAFTTC5	REMACHE ROSC M 5	0,5 - 3,0	6,9	10	1,2	13,0	5.000	64,00 € /mil
FAFTTC6	REMACHE ROSC M 6	0,5 - 2,3	8,9	12	1,5	14,5	5.000	70,00 € /mil
FAFTTC8	REMACHE ROSC M 8	0,8 - 3,5	10,9	15	1,5	17,5	2.500	106,00 € /mil
FAFTTC10	REMACHE ROSC M 10	1,0 - 3,5	11,9	16	1,7	19,0	2.000	160,00 € /mil

* medidas en milímetros.

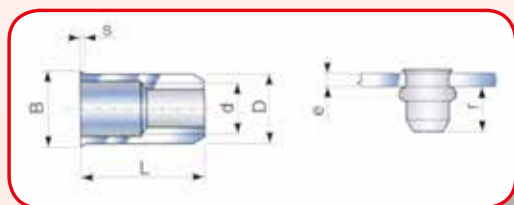

FTR

Remache Roscado Sin Cabeza



REFERENCIA	REMACHE ROSCADO FTR [SIN CABEZA/BALONA]	E	D	B	S	L	CAJA	PVP
FAFTRC3	REMACHE ROSC M 3	0,5 - 1,5	4,9	5,5	0,3	8,5	10.000	56,00 € /mil
FAFTRC4	REMACHE ROSC M 4	0,5 - 1,5	5,9	6,75	0,4	10,0	10.000	60,00 € /mil
FAFTRC5	REMACHE ROSC M 5	0,5 - 2,0	6,9	8,0	0,4	12,0	5.000	64,00 € /mil
FAFTRC6	REMACHE ROSC M 6	0,5 - 2,0	8,9	10,0	0,4	13,5	5.000	70,00 € /mil
FAFTRC8	REMACHE ROSC M 8	1,0 - 2,5	10,9	12,0	0,4	16,5	2.500	106,00 € /mil
FAFTRC10	REMACHE ROSC M 10	1,0 - 2,5	11,9	13,5	0,4	18,0	2.000	160,00 € /mil

* medidas en milímetros.

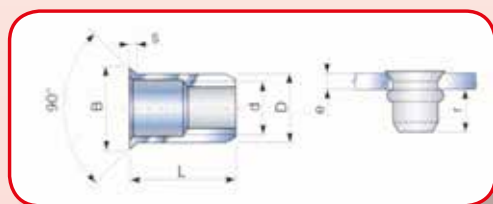

FTS

Remache Roscado Cabeza Cónica



REFERENCIA	REMACHE ROSCADO FTS [CABEZA/BALONA CÓNICA]	E	D	B	S	L	CAJA	PVP
FAFTSC3	REMACHE ROSC M 3	1,5 - 2,8	4,9	8,0	1,5	9,5	10.000	56,00 € /mil
FAFTSC4	REMACHE ROSC M 4	1,5 - 3,5	5,9	9,0	1,5	11,0	10.000	60,00 € /mil
FAFTSC5	REMACHE ROSC M 5	1,5 - 3,8	6,9	10,0	1,5	13,0	5.000	64,00 € /mil
FAFTSC6	REMACHE ROSC M 6	1,5 - 3,8	8,9	12,0	1,5	15,0	5.000	70,00 € /mil
FAFTSC8	REMACHE ROSC M 8	1,5 - 3,8	10,9	14,0	1,5	16,5	2.500	106,00 € /mil
FAFTSC10	REMACHE ROSC M 10	1,5 - 3,8	11,9	15,0	1,5	18,0	2.000	160,00 € /mil

* medidas en milímetros.

herramienta
manual

aire

maquinaria
neumática

remachadoras

maquinaria
eléctrica

jardín

accesorios

clavadoras
grapadoras